



CELEBRATING 50 YEARS OF KINETIC

KEL:SH:SE

Date:12 February 2026

To,
The Manager-Corporate Relations Department
BSE Limited
1st Floor, P J Towers
Fort, Mumbai- 400 001.

BSE Scrip Code: 500240

Subject: Investor Presentation

Dear Sir/Madam,

Pursuant to Regulation 30 of the SEBI (Listing Obligations and Disclosure Requirements) Regulations 2015, please find enclosed herewith the Investor Presentation.

This is for your information and records.

Thanking you.
Yours faithfully,

For Kinetic Engineering Limited

Chaitanya
Mundra

Digitally signed by Chaitanya Mundra
DN: cn=Chaitanya Mundra,
ou=Personal,
serialNumber=624465a83ad42169f8655b0e1430d,
2.5.4.20=0a69c2e6b4f366b49f3a9632a3c3f63d900
a8113eefefc6c0d90a4d2, postalCode=753031
st=Orissa,
serialNumber=84305ab3c817bdeaf5e6e6330821d7e
0d19b0ec02490204ac6fed0c800d46, cn=Chaitanya
Mundra
Date: 2026.02.12 11:21:18 +05'30'

Chaitanya Mundra
Company Secretary and Compliance Officer

KINETIC ENGINEERING LTD

HEAD OFFICE:
Kinetic Innovation Park
D-1 Block, 18/2 MIDC, Chinchwad,
Pune, Maharashtra 411019, India

FACTORY:
Kinetic Manufacturing Plant
Nagar-Daund Road,
Ahmednagar 414001, India

CONTACT:
+91 20 66142049
www.KineticIndia.com
CIN:L35912MH1970PLC014819

KINETIC ENGINEERING LTD.

INVESTOR PRESENTATION

Q3 & 9M FY26

Refer to Disclaimer

DISCLAIMER

This document has been prepared for information purposes only and is not an offer or invitation or recommendation to buy or sell any securities of Kinetic Engineering Ltd. ("Kinetic Engineering", "KEL", "Company"), nor shall part, or all, of this document form the basis of, or be relied on in connection with, any contract or investment decision in relation to any securities of the Company. This document is strictly confidential and may not be copied, published, distributed or transmitted to any person, in whole or in part, by any medium or in any form for any purpose. The information in this document is being provided by the Company and is subject to change without notice. The Company relies on information obtained from sources believed to be reliable but does not guarantee its accuracy or completeness. This document contains statements about future events and expectations that are forward-looking statements. These statements typically contain words such as "expects" and "anticipates" and words of similar import. Any statement in this document that is not a statement of historical fact is a forward-looking statement that involves known and unknown risks, uncertainties and other factors which may cause our actual results, performance or achievements to be materially different from any future results, performance or achievements expressed or implied by such forward-looking statements. None of the future projections, expectations, estimates or prospects in this document should be taken as forecasts or promises nor should they be taken as implying any indication, assurance or guarantee that the assumptions on which such future projections, expectations, estimates or prospects have been prepared are correct or exhaustive or, in the case of the assumptions, fully stated in the document. The Company assumes no obligations to update the forward-looking statements contained herein to reflect actual results, changes in assumptions or changes in factors affecting these statements. You acknowledge that you will be solely responsible for your own assessment of the market and the market position of the Company and that you will conduct your own analysis and be solely responsible for forming your own view of the potential future performance of the business of the Company.



01. ABOUT US

02. BUSINESS OVERVIEW

03. KEL: VALUE DRIVERS

**04. PERFORMANCE
HIGHLIGHTS**

05. WAY FORWARD

**06. ANNUAL FINANCIAL
HIGHLIGHTS**

TABLE OF CONTENT

ABOUT US

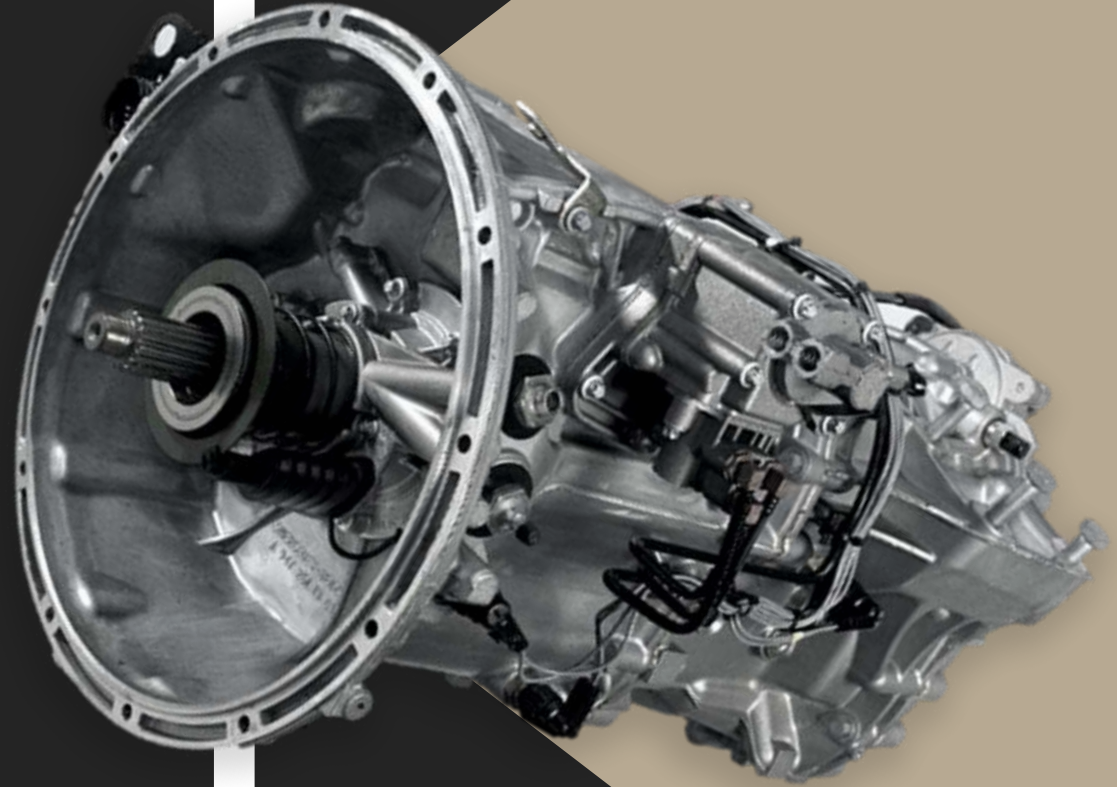

OUR JOURNEY



1975

Converted to a **public limited company** on **October 1**.



1972

The company was established and began operations **with the launch of the Kinetic Luna moped**, which **achieved significant domestic sales and exports**.



1970

KEL was **founded** by **H.K. Firodia**.



1984

Formed a **joint venture with Honda Motor Company**, introducing Kinetic Honda scooters with electric start and gearless transmissions.



1998

Kinetic **acquired Honda's stake in the joint venture**, rebranding as Kinetic Motors.



2008

Entered into a **joint venture with SYM a Taiwanese motorcycle company**, to bring new products to Indian market.



2024-25

New Additions:

- **Nylon Coating unit**
 - **Automated welding facility**
 - **Solar power project**
- (The Solar project is projected to save Rs. 6 Crore annually)



2022

Kinetic **Watts & Volts** was formed in September 2022 as a subsidiary of Kinetic Engineering with a **vision to provide integrated solutions for EV customers**.



2011

Shifted **focus to automotive components manufacturing, supplying to various industries**, including automotive and off-highway applications.

LEAD MANAGEMENT

Late Mr. H.K. Firodia - The Doyen of Indian Automobile

Mr. H.K. Firodia, fondly known as the Doyen of the Indian Automobile Industry, played a pivotal role in shaping iconic companies like Bajaj Auto, Force Motors, and Kinetic Honda. He was instrumental in laying the foundation of India's thriving automobile sector, leaving behind a proud legacy for the Kinetic Group.

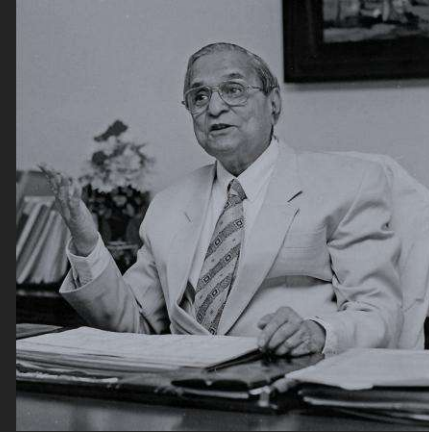

Padma Shri Dr. Arun Firodia - Chairman

Padma Shri Dr. Arun Firodia, the chairman of Kinetic Group is an epitome of the combination of a brilliant engineer and an astute businessman' Apart from being a leading industrialist, Dr. Arun Firodia is also a prominent social activist' Born to Shri H.K. Firodia in 1943, Dr. Arun Firodia obtained his B. Tech degree with distinction in Electrical Engineering from IIT Mumbai in 1965. He continues the rich tradition of his distinguished father, Late Shri H K Firodia.



Ajinkya Firodia - Vice Chairman & Managing Director

Ajinkya Firodia, Vice Chairman & Managing Director of Kinetic Engineering Ltd., is a distinguished industrialist from the Firodia family, pioneers in the Indian automobile industry. He graduated from Brown University, USA. He holds a double degree in engineering & economics and began his career as an M&A analyst at J.P. Morgan Chase.



"To drive innovation and excellence in the automotive industry by delivering high-quality components, embracing sustainable technologies"

MISSION

Innovation and Excellence: KEL emphasizes continuous innovation and strives for excellence in engineering, aiming to set industry benchmarks.

Sustainable Technologies: The company is actively investing in the electric vehicle (EV) sector, reflecting its commitment to sustainable and future-ready technologies.

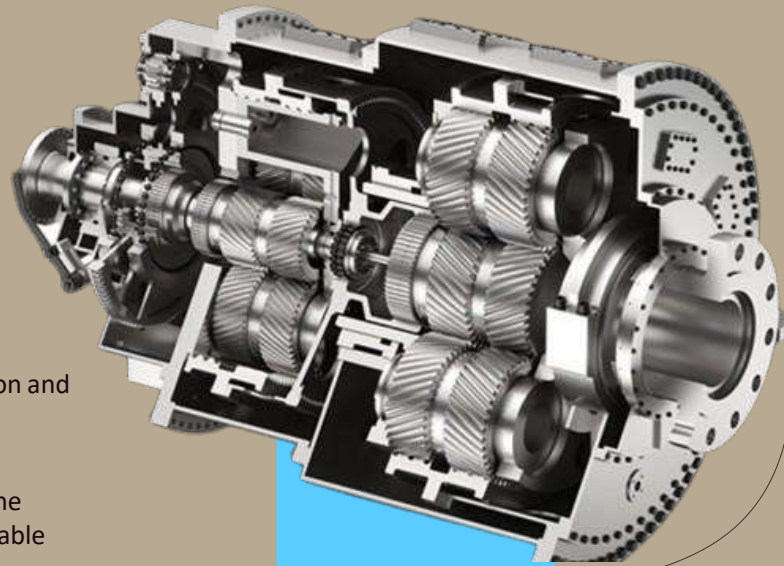

VISION

To be a global leader in automotive and mobility solutions, driving innovation and embracing sustainability through cutting-edge engineering and manufacturing excellence.

KINETIC GROUP COMPANIES



Transmission & Driveline



PCB, Controllers & Motors



Elevators & Escalators



Branding & Digital solution



EV Division



Lithium ion Batteries



Premium Motorcycles



Real Estate Investments

BUSINESS OVERVIEW

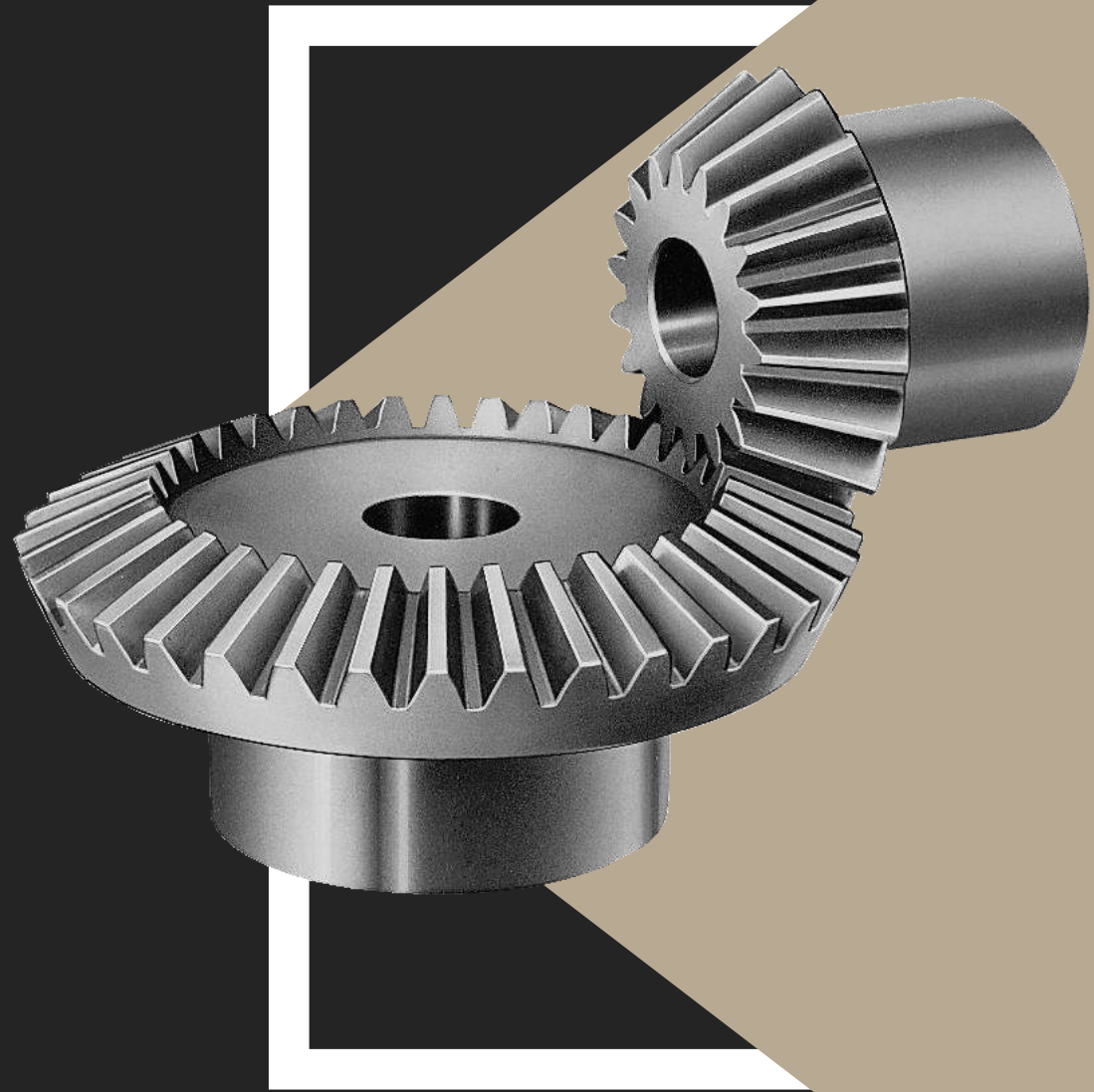

GROUP STRUCTURE



1. Kinetic Engineering Ltd (KEL)

Transmission Vertical: Gearboxes, Planet Gears, Sun Shafts.

Driveline Vertical: Spline Yoke, Stub Shaft.

EV Vertical: Rigid Axles, Trans Axles, Chassis Bodies, 2 Wheeler GB Assembly.

Customer Base: Supplies to major OEMs such as Tata Motors, Mahindra, Ashok Leyland, etc. & export market.

2. Kinetic Communication Ltd (KCL)

KCL develops and manufactures Complete EV powertrain solutions for 2w & 3w:

- BLDC Hub Motors
- Motor Controllers
- EV Battery Chargers

Group Company (0.3% Equity)

3. Micro Age Instruments Pvt. Ltd. (MAIPL)

- EV battery manufacturing under the Range-X brand.
- Annual production capacity of 60,000 units.
- Batteries will be used for captive consumption and sales to other OEMs.

Holding Entity in Kinetic Engineering Ltd. - (24.9% Equity)

4. Kinetic Watts & Volts Ltd. (KWVL)

- Design Development and manufacturing of EV mobility Solutions.
- Will integrate components from KEL (mechanical), KCL (electrical), and MAIPL (battery).

Subsidiary Company (79.8% Equity)

1. Kinetic Engineering Limited



Kinetic Engineering Limited (KEL) has Over **50 years of legacy** in India's auto industry. Founded by **Late Mr. H.K. Firodia**.



Creator of the iconic:

- **Kinetic Luna**
- **Kinetic DX** - India's first gearless scooter.
- **Blaze 165 cc** - India's first moto scooter.



Three Key Verticals:

- **Transmission Vertical**
- **Driveline Vertical**
- **EV Vertical**



Manufacturing facility spread over **50+ acres** in **Ahmednagar, Maharashtra** with **1000+ employees**.



Certified with **IATF 16949**, a globally recognized quality standard, reinforcing the company's commitment to world-class automotive manufacturing excellence.



BUSINESS PROCESS

Raw Material Procurement

Sourcing high-quality raw materials such as steel, Aluminium, and alloys.

Establishing vendor partnerships for cost-efficient and timely procurement.



Forging & Machining

Forging & casting of essential components like gears, shafts, axles, and chassis parts.

Precision machining for enhanced durability and performance.



Component Manufacturing

Production of gearboxes, shafts, differential assemblies, rigid axles, and powertrain components for ICE and EV vehicles.

Supply of chassis, driveline solutions, and transmission parts for two-wheeler and three-wheeler EVs.

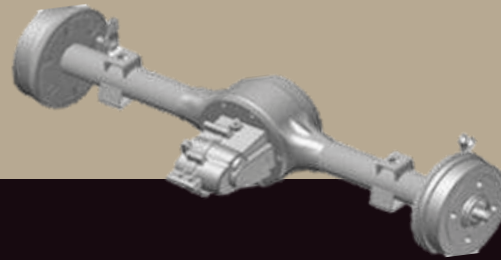

Quality Control & Testing

Implementing stringent quality checks and durability testing to ensure industry standards.

Testing for load-bearing capacity, performance, and efficiency.

Assembly & Integration

Integration of components into full assemblies before supplying to OEMs.

Ensuring compatibility with ICE, hybrid, and EV powertrains.

Distribution & Supply Chain Management

Supplying to domestic and international OEMs, Tier-1 suppliers, and aftermarket distributors.

Managing logistics to optimize cost and delivery efficiency.

TRANSMISSION VERTICAL

Gears & Gearbox Expertise

With 50+ years of experience, specialize in custom gears and constant mesh gearboxes, delivering tailored, high-quality solutions for optimal performance and reliability.



Planet Gear



Gearboxes

Shaft & Sleeves

Manufactures high-quality shafts and precision sleeves, ensuring smooth transmission and enhanced performance in automotive applications.



Sun Shaft



Shifter Sleeve

Broached Parts & Knuckle Assembly

Kinetic Engineering utilizes advanced broaching technology and expertise to deliver precision broached parts and knuckle assemblies, ensuring top-quality performance and compliance with automotive standards.



Disk Brake Tow Hub



Knuckle Assembly



Spline Yoke

Spline yoke components are designed for exceptional durability and drivetrain efficiency, using advanced materials and manufacturing techniques.

Ideal for passenger, commercial, and specialty vehicles, they ensure superior performance and reliability in all driving conditions.

DRIVELINE VERTICAL



Stub Shaft

Team of skilled engineers ensures each stub shaft is precision engineered to meet or exceed industry standards for accuracy and surface finish, delivering exceptional performance and durability for the automotive industry.

EV (2W & 3W) Vertical



Rigid Axle

Specialized in high-performance rigid axles, engineered for **exceptional durability** and **seamless power transmission**, ensuring **reliable performance in commercial and passenger vehicles**.

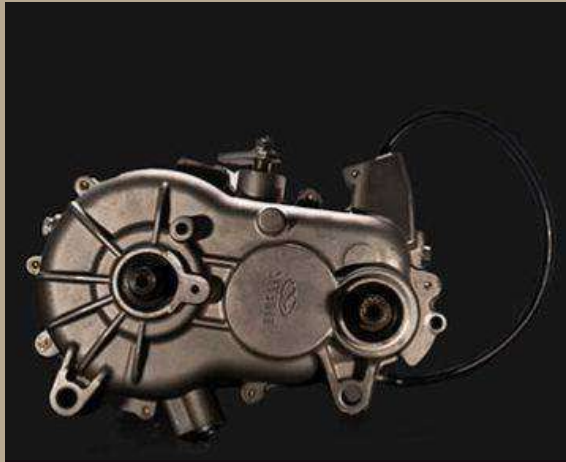

Trans Axle

Kinetic Engineering specializes in high-performance trans-axles, designed for **seamless power transmission** and **efficient integration** across diverse vehicle applications, ensuring **optimal performance and reliability**.



Chassis and body parts

The **Electric two Wheelers chassis** features an **innovative design** and **meticulous craftsmanship**, delivering **exceptional performance and durability**.



2-Wheeler GB Assembly

Kinetic Engineering pioneers innovative 2-wheeler GB Assemblies, enhancing electric mobility with seamless performance.

2. Kinetic Communications Ltd.

Group company - (0.3% Equity)

Founded in 1995 by Padmashri Dr.
Arun Firodia

KCL Develops and manufactures complete
EV powertrain solutions for electric
2-wheelers and 3-wheelers.



BLDC Hub Motor



EV battery Charger



Offers the wide range of customized EV powertrain solutions for
2W & 3W:

- BLDC hub motors & frame-mounted motors
- BLDC & Controllers
- Touchscreen display clusters with navigation & mirroring
- DC-DC converters & EV battery chargers

Facility: Pimpri-Chinchwad, Pune.

3. Mirco Age Instruments Pvt Ltd.

Holding Entity in Kinetic Engineering Ltd. - (24.9% Equity)

Micro Age Instruments Pvt. Ltd. **established in 1980**

**Recent Strategic Shift to:
EV Battery Manufacturing**



RANGE-X

Commissioned a **battery manufacturing plant**

Annual Capacity - 60,000 units

Facility: Ahmednagar, Maharashtra.

This facility aims to produce **advanced LFP & NMC EV batteries** aligning with the growing demand for electric vehicle.

4. Kinetic Watts & Volts Ltd.

Subsidiary company - (79.8% Equity)

Established - September 2022

A subsidiary of Kinetic Engineering Ltd:

KWVL is the group's dedicated venture into the **electric vehicle (EV)** segment **acts as Design, Development & manufacturing unit** within Kinetic Group's EV supply chain. The new Kinetic DX model has been relaunched under KWV.



THE RE-INCARNATION

KINETIC DX

KINETIC DX+





PRESENT BUSINESS PLAN

Who we are

- KWVL builds on the decades-old legacy of Kinetic in the Indian automotive industry
- Led by Mr. Ajinkya Firodia, Vice Chairman of Kinetic Group
- Focus on Innovation and Sustainability

Where we are

-  **Recognized at Pride of India Conclave 2025**
A prestigious honor affirming our leadership in India's electric mobility revolution.
-  **Strategic Focus on EV Core Components**
Deep investment in key EV parts (motor, controller, battery pack) to strengthen India's self-reliance in clean tech.
-  **Dedicated R&D for Scalable Innovation**
Robust in-house R&D ensures future-ready products tailored for Indian roads and user needs.
-  **Future-Ready Manufacturing Facility**
Equipped with Industry 4.0 practices, our plant is designed to scale sustainably and deliver quality at speed.
-  **Contributing to National Priorities**
Aligned with Make in India, Aatmanirbhar Bharat, & India's Net Zero 2070 vision through clean mobility solutions.
-  **Strong Leadership Backed by Legacy**
Guided by the Firodia family legacy, combining experience with a progressive EV mindset.
-  **Talent-Driven Culture**
Building a next-gen workforce equipped to lead India's transition to electric mobility.



Goal

- Expansion into Global Markets by 2027.
- Launch electric scooters and motorcycles, delivery-focused 2Ws.
- In-house development and IP ownership of motors, controllers, and battery packs.
- Build strategic alliances to create an end-to-end battery charging ecosystem for customers.
- Achieving EBITDA Profitability by FY27
- Building a 500+ Strong Dealer & Service Network
- Our objective is to establish ourselves as one of the top three players in India's electric scooter market.



Execution Strategy

- Scalable Product Strategy
- Robust Supply Chain & Vendor Partnerships
- In-House R&D & IP Development
- Process-Driven Manufacturing Excellence
- Strong Distribution & digital-first D2C Network
- Focus on reliability, after-sales, and real-world performance.
- People-First Culture & ESOP Empowerment
- Transparent Governance & IPO-Ready Compliance



Market Share

- India is the world's largest two-wheeler market, with ~17 million units sold annually.
- EV 2-wheelers currently hold ~6–7% share (~1.1 million units in FY24), expected to cross 20–25% by FY30.

KWVL's Strategic Opportunity

- Projected Market Size in FY28: ~4.48 million units (assuming a 35% CAGR)
- Building competitive edge through cost innovation, post-sales service, and in-house tech.

KINETIC RE-ENTERS TWO-WHEELER MARKET

Introducing the All-New Electric Kinetic DX & DX+ Launched under its EV subsidiary **Kinetic Watts and Volts Ltd.**, KEL revives its iconic DX scooter in a modern electric avatar. Kinetic DX, a household name from the 90s, reborn with cutting-edge EV tech.

Strategic Backing
₹ 72 Cr already invested in KWW;
promoters are aiming to further invest
₹177 Cr to scale the DX platform.

Battery & Performance:

Range up to
116KM

Powered by **Range-X 2.6 kWh** LFP battery with up to **116 km IDC range** (DX+)

4x Longer
Performance

4x longer lifecycle (2,500–3,500+ cycles) vs. typical NMC batteries

Thermal
Sensitivity

Better **thermal sensitivity**, making it safer in Indian conditions

K-Coast Tech

60V system with **K-Coast regenerative technology** for high efficiency

Charging

0-50% charge in **2 hours**; **0-100%** charge in **4 hours**



MANUFACTURING PLANT - AHMEDNAGAR

AHMEDNAGAR FACTORY
est 1970



50+
Acres

32+
Production Sheds

460+
Robust Machines

Ahmednagar Factory

Employs 1,000+ people.

Serves Key automation segments:

- Commercial Vehicles
- Passenger Car
- Tractor
- Two-Wheelers



IATF 16949 Certified

A mark of global quality compliance in
automotive manufacturing.

INFRASTRUCTURE AT THE PLANT

FORGINGS



GEAR CUTTING



PAINTING & PLATING



HEAT TREATMENT



PRECISION MACHINING



ELECTRIC DIVISION



OUR CUSTOMERS

INTERNATIONAL



DOMESTIC



KEL: VALUE DRIVERS

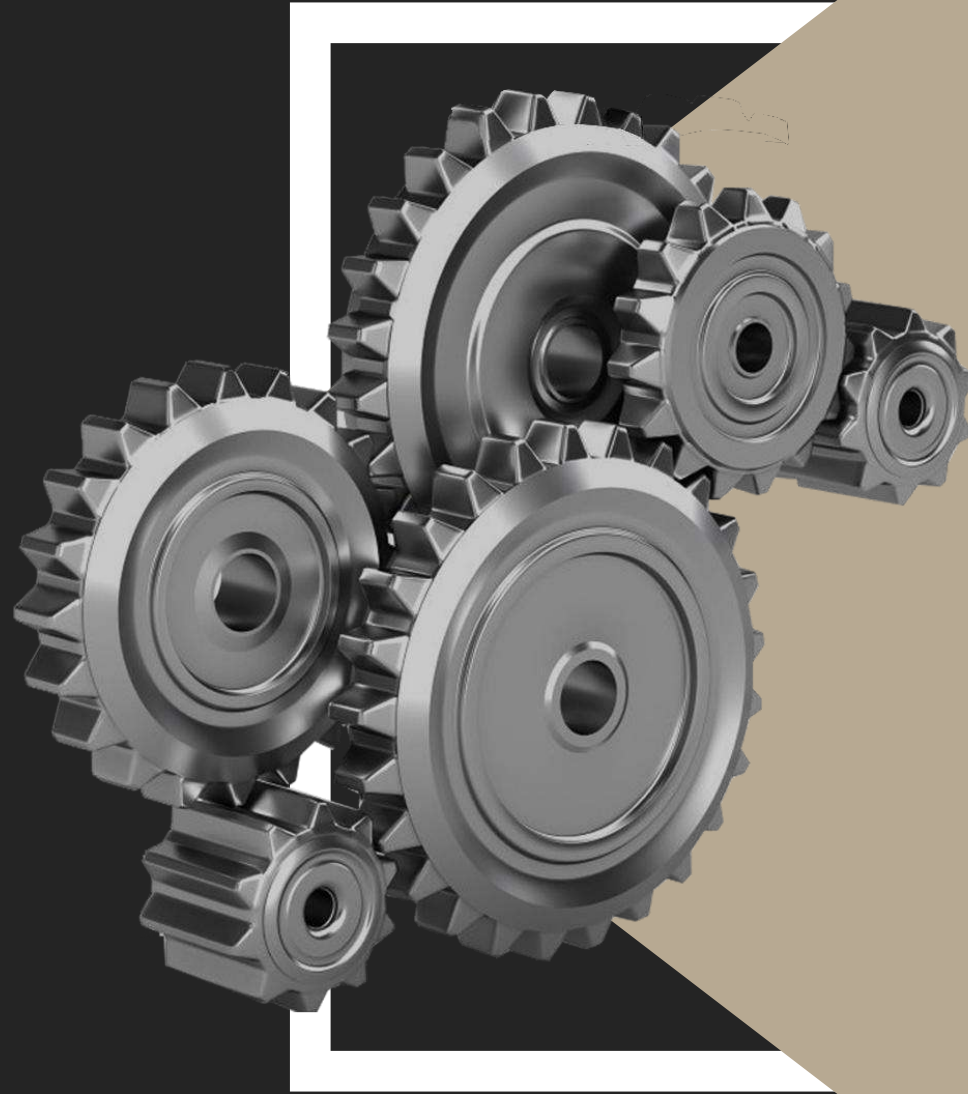

EVOLUTION OF KEL

Phase 1 (1972-2010)

The phase when legacy was built

- Pioneered India's two-wheeler revolution with **Kinetic Luna** and **Kinetic DX - iconic scooters**.
- Formed a successful JV with Honda (**Kinetic Honda Motor Company**).
- Expanded presence in domestic and international markets with strong product portfolio.
- Built large-scale manufacturing & R&D infrastructure in **Ahmednagar**.

Phase 2 (2011-2022)

The phase of realignment and strengthening of core

- Transitioned focus from **vehicle manufacturing to auto component manufacturing**.
- Developed expertise in **drivetrain, transmission components, and precision engineering**.
- Expanded OEM partnerships across domestic and international markets.
- Promoter group gradually increased stake, indicating confidence in revival.
- Formed EV-focused subsidiaries like **Kinetic Watts & Volts Ltd**.

Phase 3 (2023 & Beyond)

The phase drive the future of mobility

- Set up advanced battery manufacturing unit (**Range-X**) in MAIPL with **60,000 units/year capacity**.
- Investing in EV drivetrain & transmission systems, **targeting 2W/3W OEMs**.
- Focused on **green mobility, electrification and expanding export markets**.

What lies ahead?

- Leverage strong promoter vision to tap into **India's growing EV ecosystem**.
- Scale EV and component businesses through new capacities and product lines.
- Continue backward integration to reduce third-party dependency.

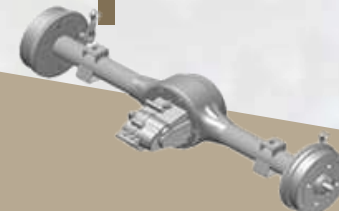
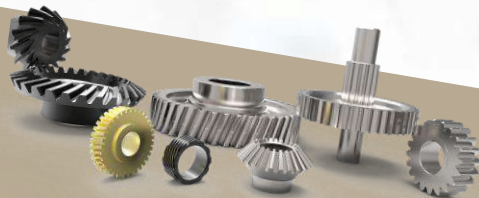
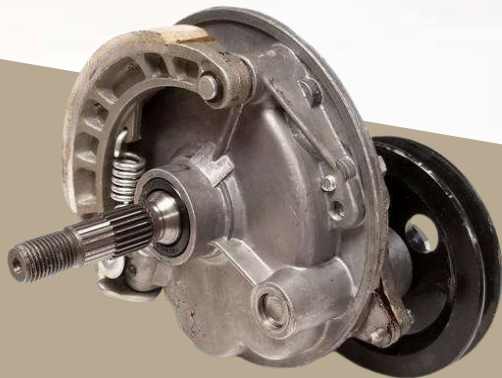

WHY KINETIC ENGINEERING?



50+ years of legacy in trusted automotive engineering.

Backward integrated operations ensuring **cost control and quality advantage.**

Expansion into EV components, battery manufacturing with **(Range-X brand).**

Dedicated EV subsidiary: Kinetic Watts & Volts Ltd to capture India's booming **EV supply chain opportunity.**

PROMOTER COMMITMENT

Promoter have infused Rs. 160 Cr through warrants payable in tranches to fuel future growth.

PROMOTER CONFIDENCE & STRATEGIC COMMITMENT



Promoter Group Shareholding Pattern (%)

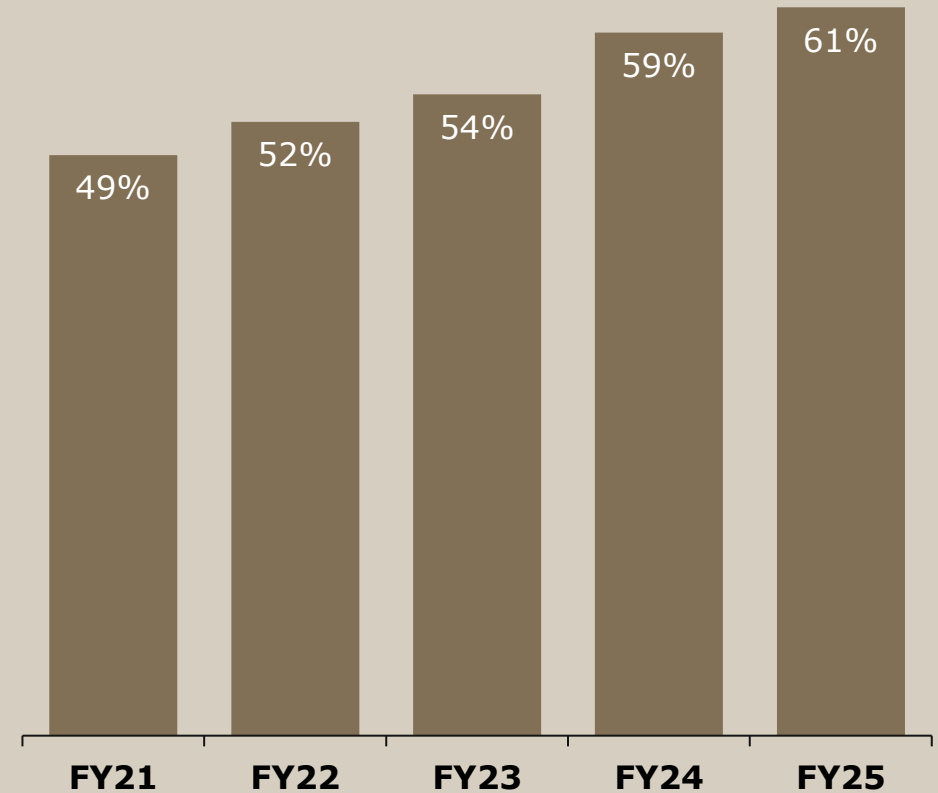

- The consistent increase in promoter shareholding reflects strong confidence in Kinetic Engineering's growth trajectory and the future of the EV and auto component industry.
- Demonstrates long-term bullishness towards both the business and the evolving EV ecosystem.
- Promoter Capital Infusion via Warrant. Details:

| Date of Issue | Warrant Size (Rs.) | Issue price (Rs.) | No of warrants issued | Converted warrant till date |
|---------------|--------------------|-------------------|-----------------------|-----------------------------|
| 27-03-2025 | 160 Crores | 171/- | 93,56,725 | 11,69,591 |

COMPETITIVE STRENGTHS

Vertically Integrated Manufacturing

- In-house production of forgings, gearboxes, shafts, and chassis components.
- End-to-end manufacturing ensures cost efficiency and quality control.

Strong Legacy & Brand Recognition

- Over 50 years of experience in the automotive industry.
- Pioneer of Kinetic Luna and India's first gearless scooter (Kinetic Honda).

Diversified Product Portfolio

- Specialization in ICE (Internal Combustion Engine) and EV components.
- Supplies transmission, driveline, and chassis parts to multiple industries.

Focus on EV Growth & Sustainability

- Expanding into EV drivetrain systems, axles, and gear solutions.
- Strong synergy with Kinetic Watts & Volts and Range-X (EV-focused subsidiary) for future growth.

Robust R&D, Manufacturing & Engineering Capabilities

- Investment in CAD, CAM, and advanced material engineering.
- Focus on lightweight and high-performance auto components.

Strong OEM & Tier-1 Client Base

- Supplies to leading automotive OEMs and Tier-1 suppliers.
- Established domestic & export business across multiple geographies.



PERFORMANCE HIGHLIGHTS

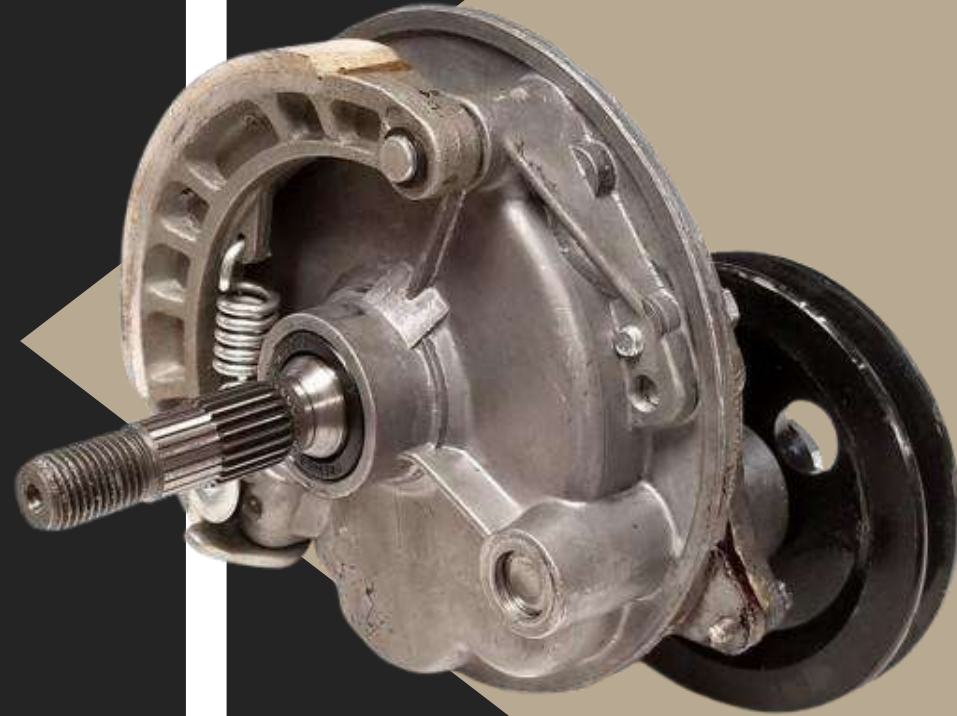

KEY BUSINESS HIGHLIGHTS

Operational Momentum

- Kinetic Engineering Ltd. (KEL) continues to build momentum across electric mobility and manufacturing.
- Growth driven by rising customer adoption, expanding retail footprint, & improved operational performance.

Electric Mobility Progress

- Cumulative EV sales have crossed **600 units**, indicating early market acceptance.
- Kinetic Watts and Volts Ltd. (KVV) currently operates **7 Kinetic EV dealerships**.
- **8 additional dealerships** scheduled by end-February, supporting a phased, market-by-market expansion strategy.

Leadership Strengthening

- Appointment of Rajesh Dhongade as **Chief Operating Officer (COO)** and Key Management Personnel.
- Brings **24+ years of experience** across automotive and industrial manufacturing.
- Expertise includes **plant setup, manufacturing scale-up, component development, operations, and business development**.
- Expected to strengthen **operational discipline and execution** during the next growth phase.

Strategic Direction

- Focused on **scaling EV operations, expanding dealer network**, and enhancing operational excellence.
- Long-term commitment to building a **sustainable, scalable mobility platform rooted in Indian manufacturing**.



Strategic Technology Partnerships & Expanding Retail Footprint

Kinetic Watts & Volts Joins Hands with Jio Things to Build India's Next-Gen Connected EVs.

Through this association, KVV will introduce a suite of new digital capabilities enabled by Jio's IoT ecosystem.

- + **Voice-assisted vehicle interaction** for convenience and safety
- + **Smart digital instrument clusters** with real-time data
- + **Connected mobility features** for performance monitoring and diagnostics
- + Enhanced infotainment applications
- + **Telematics and cloud-based analytics** for fleet operators

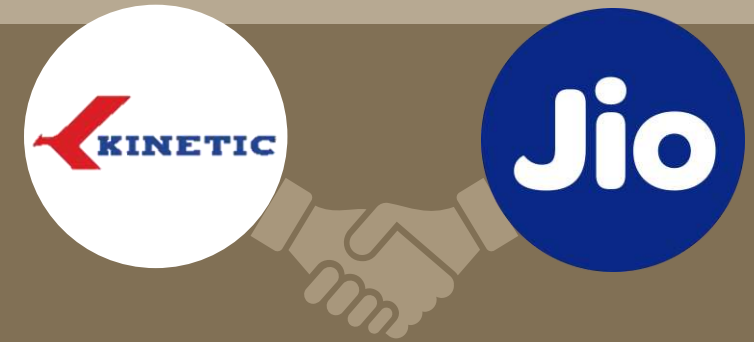

Jio Things provides a fully integrated IoT ecosystem spanning **edge devices, connectivity, cloud infrastructure, device management, installation, and aftermarket support**. Integrating this full-stack platform into Kinetic EVs will enable seamless **digital connectivity, enhance user experience, and support both individual customers and commercial fleet operations**.

Existing Showrooms

| Location | No. of Showrooms |
|----------|------------------|
| Pune | 4 |
| Thane | 1 |
| Gujarat | 2 |

Upcoming Showrooms

| Location | No. of Showrooms |
|----------|------------------|
| NCR | 3 |
| Delhi | 1 |
| Pune | 1 |
| Indore | 1 |
| Gwalior | 1 |

By the end of March, **~15 additional** showrooms are expected to be added, taking the total retail network to **approximately 30**

Kinetic Watts & Volts Ltd.

Launch of “Kinetic Lab”

Kinetic Lab –

A dedicated Two-Wheeler EV Technical Training Centre – has been inaugurated to upskill technicians, service engineers, & dealer staff for India’s expanding electric mobility ecosystem.

Strategic Significance

- Strengthens **after-sales infrastructure** and ensures **EV-ready workforce** across India.
- Builds **technical competency** – a critical pillar of **customer trust and retention** in EV adoption.
- Supports Kinetic’s **nationwide dealer network** with standardized diagnostics, service protocols, and safety practices.

Key Focus Areas

- Deep technical expertise in **EV powertrains and battery systems**
- **Standardized repair protocols** and **diagnostic workflows**
- Creation of **EV “Master Technicians”** and **EV Champions** for dealer-level leadership

Expected Impact

- Higher **First-Time Fix Ratio** and **lower vehicle downtime**
- Improved **diagnostic accuracy** and **service quality**
- Strengthened **customer experience** and **brand reliability**
- EV-ready technicians deployed across urban and emerging Tier 2–3 markets

With Kinetic Lab, Kinetic Watts & Volts Ltd. becomes one of the few Indian EV manufacturers to establish a dedicated training facility — reinforcing its long-term commitment to quality, reliability, and scalable EV service excellence.



CONSOLIDATED QUARTERLY INCOME STATEMENT

| Particular (INR Mn) | Q3FY26 | Q2FY26 | Q3FY25 | YoY% | QoQ% | 9MFY26 | 9MFY25 | YoY% |
|--------------------------------|--------------|--------------|---------------|----------------|---------------|----------------|----------------|---------------|
| Net Sales | 383.7 | 393.0 | 289.0 | 32.8% | -2.4% | 1,130.1 | 1,039.3 | 8.7% |
| Total Income | 383.7 | 393.0 | 289.0 | 32.8% | -2.4% | 1,130.1 | 1,039.3 | 8.7% |
| Total expenditure | 363.5 | 376.3 | 304.0 | 19.6% | -3.4% | 1,113.5 | 1,020.4 | 9.1% |
| EBITDA | 20.2 | 16.7 | -15.0 | 100.0% | 21.0% | 16.6 | 18.9 | -12.2% |
| EBITDA Margin (%) | 5.3 | 4.2 | -5.2 | 1,045 bps | 102 bps | 1.5 | 1.8 | -35 bps |
| Other Income | 8.5 | 12.6 | 4.8 | 77.1% | -32.5% | 31.5 | 18.6 | 69.4% |
| Depreciation | 15.4 | 14.9 | 16.7 | -7.8% | 3.4% | 44.9 | 49.2 | -8.7% |
| EBIT | 13.3 | 14.4 | -26.9 | 100.0% | -7.6% | 3.2 | -11.7 | 100.0% |
| Interest | 11.8 | 16.1 | 12.3 | -4.1% | -26.7% | 43.9 | 31.9 | 37.6% |
| PBT | 1.5 | -1.7 | -39.2 | 100.0% | 100.0% | -40.7 | -43.6 | 6.7% |
| Tax | - | - | - | - | - | - | - | - |
| Adjusted PAT | 1.5 | -1.7 | -39.2 | 100.0% | 100.0% | -40.7 | -43.6 | 6.7% |
| Exceptional Items* | - | - | 69.8 | | | 45.8 | 100.9 | -54.6% |
| Reported PAT | 1.5 | -1.7 | 30.6 | -95.1% | 100.0% | 5.1 | 57.3 | -91.1% |
| Adjusted PAT Margin (%) | 0.4% | -0.4% | -13.6% | 1,395 bps | 82 bps | -3.6% | -4.2% | 59 bps |
| Reported PAT Margin (%) | 0.4% | -0.4% | 10.6% | -1,020 bps | 82 bps | 0.5% | 5.5% | 506 bps |
| Reported EPS (Rs.) | 0.09 | -0.03 | 1.41 | -93.62% | 100.0% | 0.33 | 2.62 | -87.4% |

*Note - Includes Profit on Sale of Non-Core Assets of Rs. 698 lakhs for Quarter Ended 31st Dec. 2024, Rs. 458 lakhs for Period Ended 31st Dec. 2025, Rs. 1009 lakhs for Period Ended 31st Dec. 2024.

GEOGRAPHICAL PRESENCE

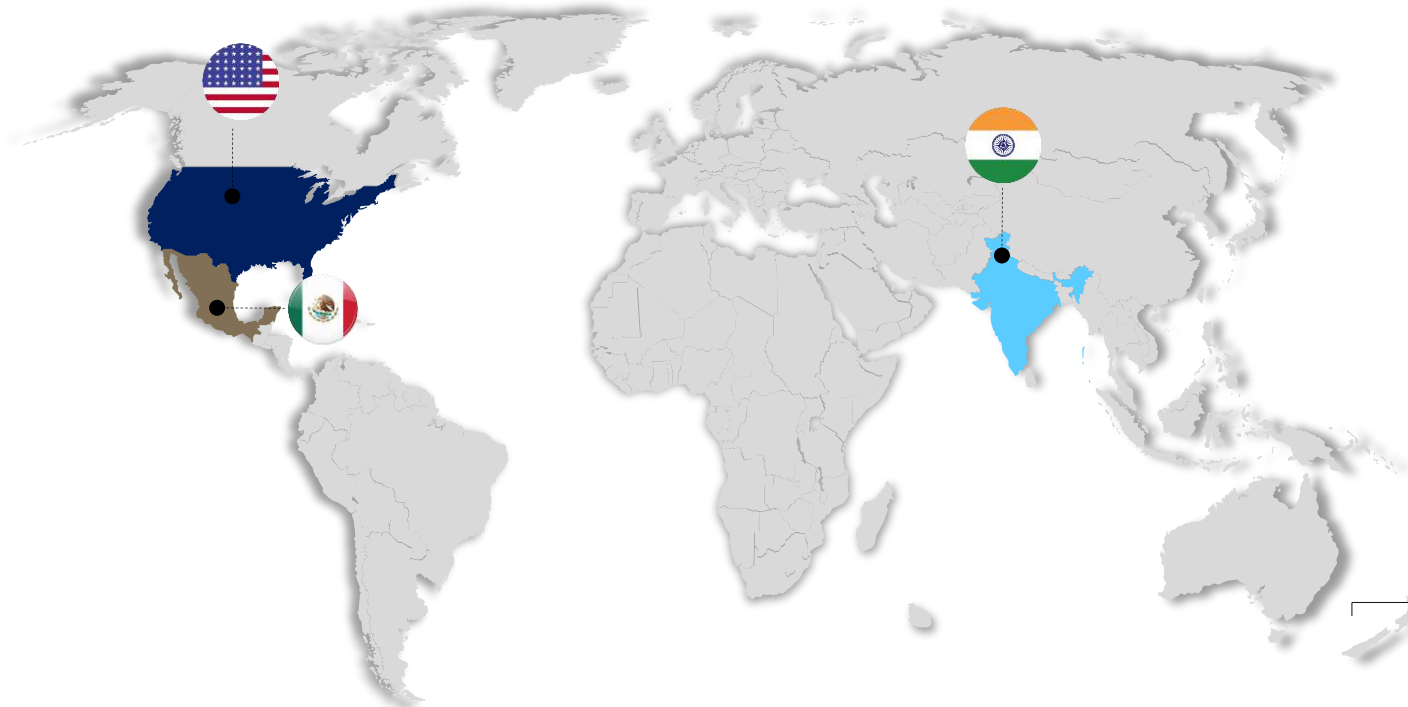

Geographical Sales Breakup %

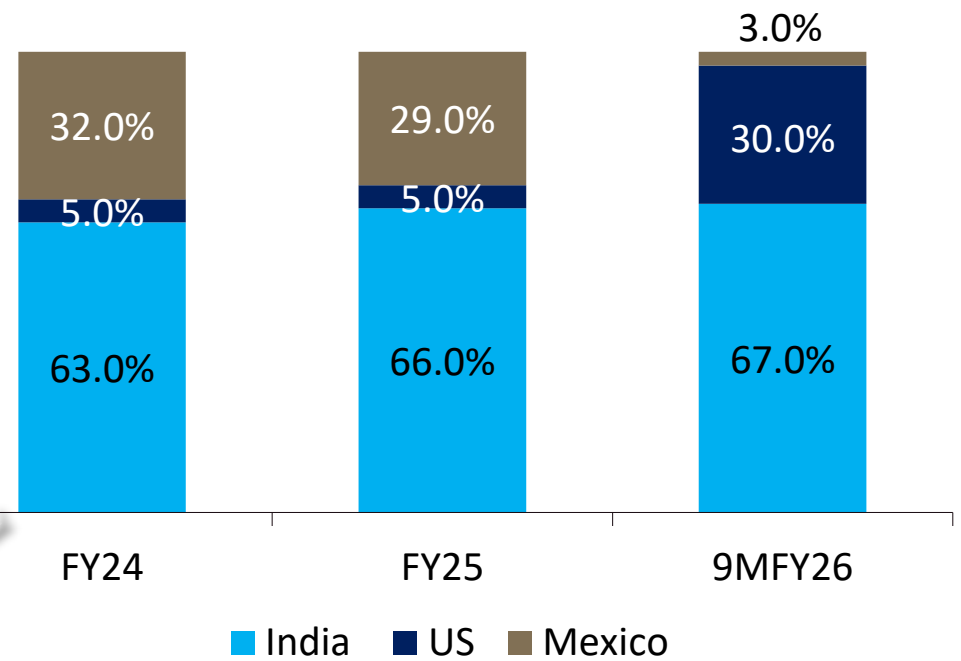

TOP CUSTOMER

Revenue from Top Customers (%)

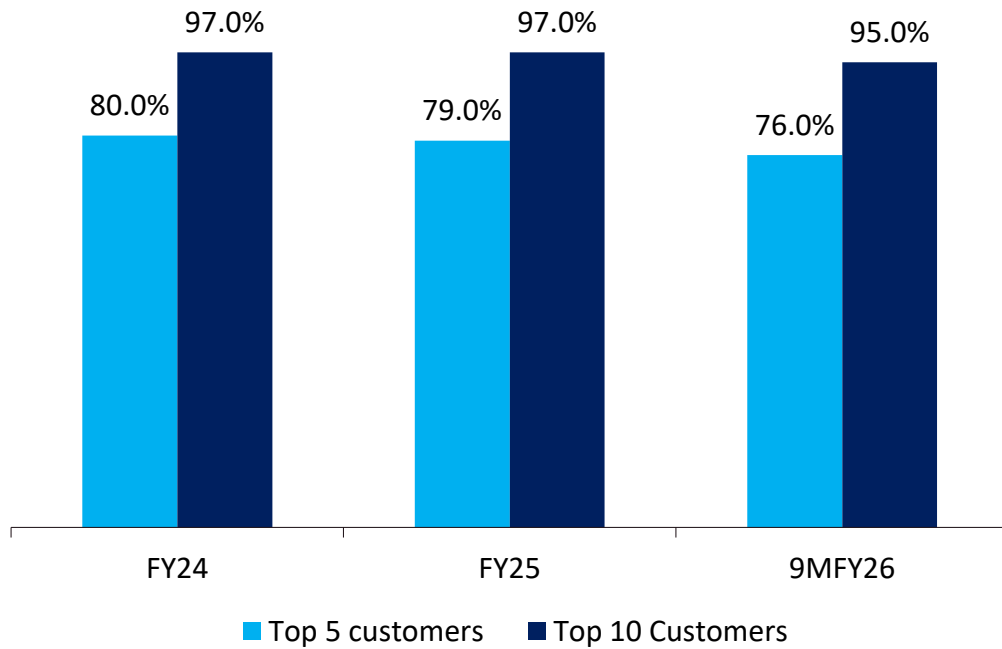

Segment wise sales Breakup (%)

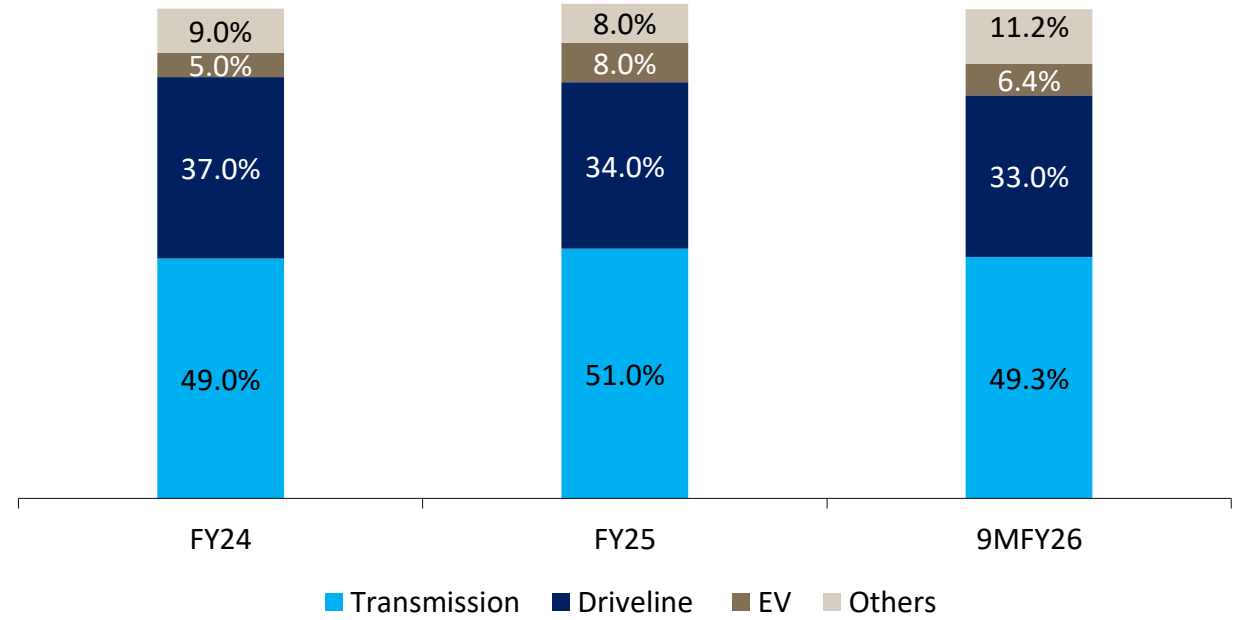

CONSOLIDATED KEY PERFORMANCE HIGHLIGHTS

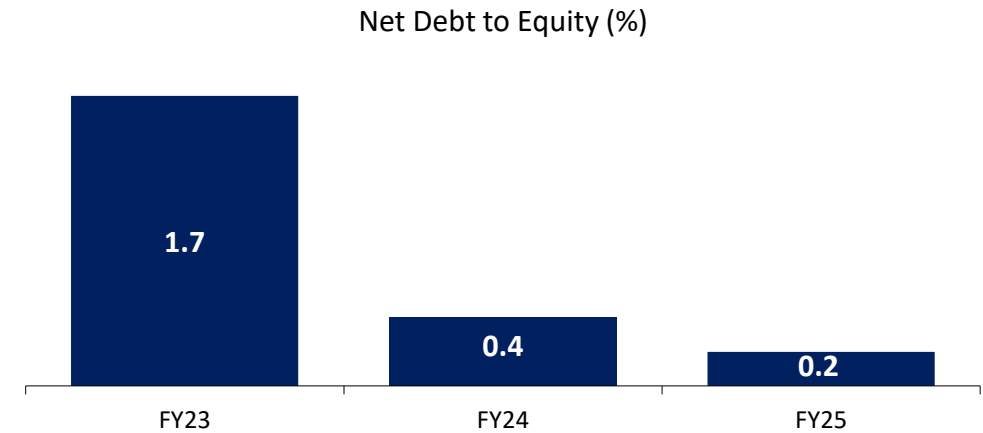
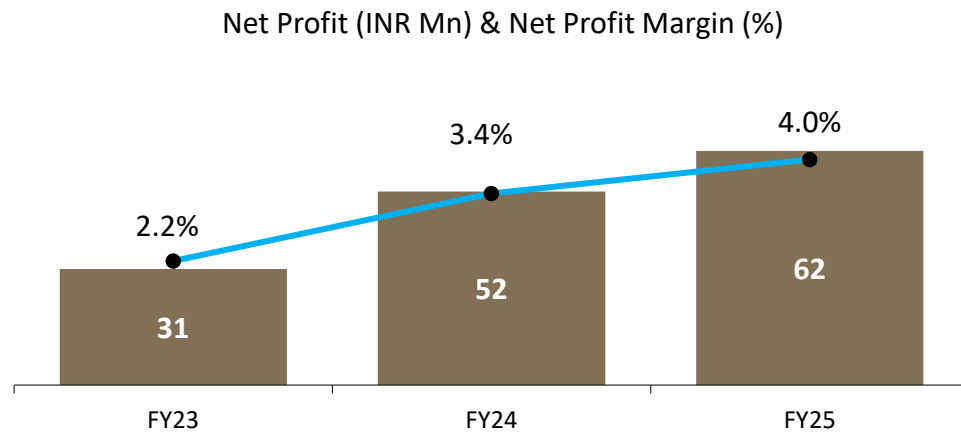
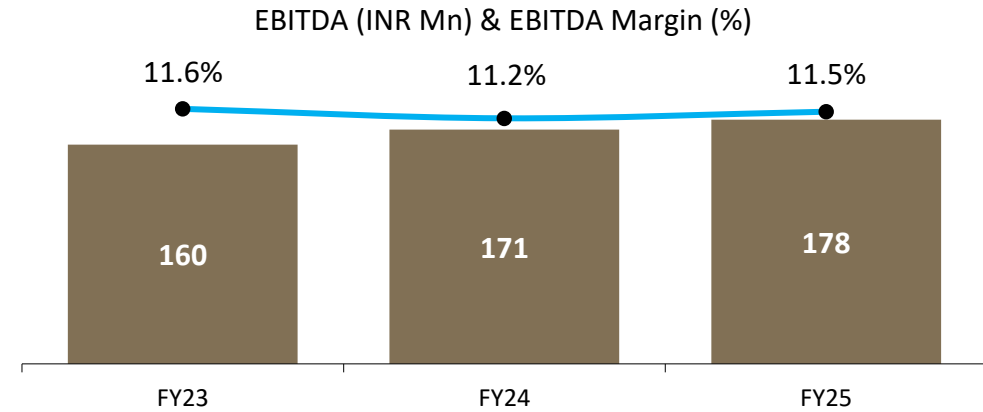
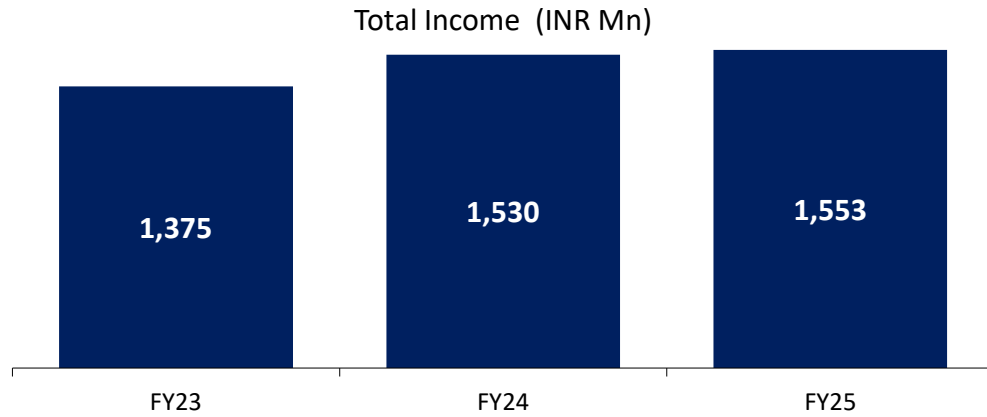

WAY FORWARD



UPCOMING PARTS OF EV

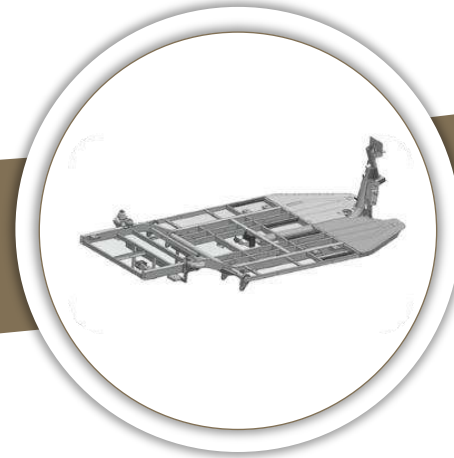

FRAMES & OTHER BODY PARTS

KEL makes **chassis, frames and body parts** such as side stand , rear forks, swing arms, main stands for 2-wheeler and 3-wheelers and supplies them duly welded and painted.

INDIA'S GROWING AUTO COMPONENT MARKET



Indian Auto Component Industry:

- Contributes ~2.3% to India's GDP and employs 1.5 million+ people directly.
- Industry revenue projected to exceed USD 80.1 billion by FY25 (ACMA).
- Driven by strong domestic demand, rising exports, and EV transition.
- EV adoption is a key growth catalyst, boosting component innovation & investments.

Current Market Size:

In FY24, the industry achieved a turnover of **(\$74.1 Billion)**, marking a **9.8%** increase from the previous year.

Key Growth Drivers:

1

Rising Domestic Demand:

Increased sales of larger vehicles, such as utility vehicles (UVs), and higher-capacity motorcycles are boosting component demand.

2

EV Component Growth:

The contribution of EV components doubled to 6% of total production in FY24, reflecting the rapid adoption of electric vehicles.

3

Technological Advancements:

Investments in new technologies, including EV components and advanced manufacturing processes, have enhanced the industry's global competitiveness.

4

Localization & Value Addition:

Efforts to localize production and enhance value addition have contributed to the industry's growth, reducing dependency on imports and improving cost competitiveness.

5

Government Initiatives:

Policies such as the Production Linked Incentive (PLI) scheme and the Automotive Mission Plan aim to boost domestic manufacturing, encourage innovation, and attract investments in the auto component sector.

Source: [IBEF](#)

ANNUAL FINANCIALS

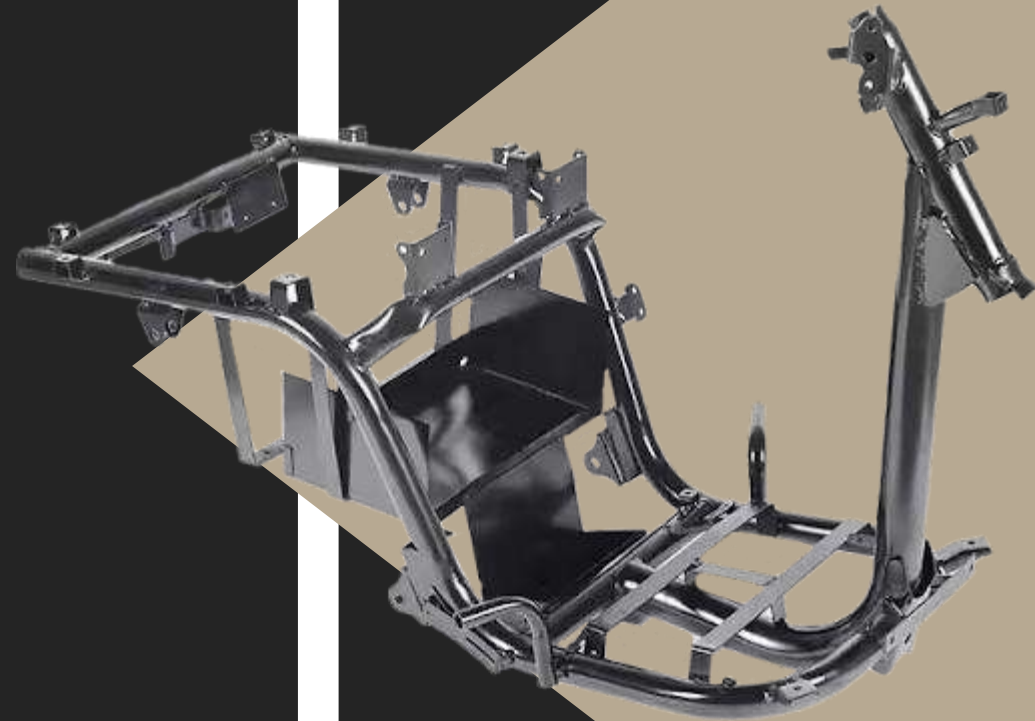

ANNUAL INCOME STATEMENT

| Particulars (INR Mn) | Standalone | | Consolidated | | |
|--------------------------------|--------------|----------------|----------------|----------------|----------------|
| | FY21 | FY22 | FY23 | FY24 | FY25 |
| Net Sales | 838.7 | 1,215.6 | 1,353.8 | 1,439.3 | 1,424.6 |
| Other Income | 31.7 | 27.9 | 21.3 | 90.4 | 128.1 |
| Total Income | 870.3 | 1,243.5 | 1,375.1 | 1,529.7 | 1,552.7 |
| Cost of Raw material Consumed | 445.2 | 695.5 | 763.3 | 837.2 | 784.1 |
| Changes in Inventory | -10.0 | -54.6 | -53.9 | -46.3 | -9.5 |
| Employee Benefits | 173.8 | 191.3 | 190.4 | 214.1 | 224.0 |
| Other expenses | 191.4 | 267.2 | 315.8 | 354.1 | 375.9 |
| Total Expenditure | 800.4 | 1,099.4 | 1,215.6 | 1,359.1 | 1,374.5 |
| EBITDA | 69.9 | 144.1 | 159.5 | 170.6 | 178.2 |
| EBITDA Margin (%) | 8.0% | 11.6% | 11.6% | 11.2% | 11.5% |
| Depreciation | 67.8 | 64.7 | 64.8 | 64.5 | 66.9 |
| PBIT | 2.1 | 79.4 | 94.7 | 106.1 | 111.3 |
| Interest | 64.4 | 65.8 | 63.9 | 54.5 | 49.0 |
| PBT | -62.3 | 13.6 | 30.9 | 51.5 | 62.3 |
| Tax | - | - | - | - | - |
| Reported Net Profit | -62.3 | 13.6 | 30.9 | 51.5 | 62.3 |
| Reported PAT Margin (%) | -7.4% | 1.1% | 2.2% | 3.4% | 4.0% |
| Reported EPS (Rs.) | -3.45 | 0.82 | 1.54 | 2.35 | 2.89 |

ANNUAL CONSOLIDATED BALANCE SHEET

| Particulars (INR Mn) | FY24 | FY25 | H1FY26 |
|---------------------------------------|----------------|----------------|----------------|
| Equity & Liabilities | | | |
| Equity | | | |
| Share Capital | 221.6 | 234.1 | 238.1 |
| Reserves and surplus | 376.4 | 796.9 | 849.9 |
| Non Controlling Interest | 44.5 | 142.6 | 140.5 |
| Total Equity | 642.5 | 1,173.6 | 1,228.5 |
| Non-Current Liabilities | | | |
| Financial Liabilities | | | |
| i) Borrowing | 290.9 | 437.1 | 489.6 |
| Provisions | 19.8 | 17.7 | 17.7 |
| Other Non-current Liabilities | 52.7 | 0.0 | 6.8 |
| Total Non-Current Liabilities | 363.4 | 454.9 | 514.1 |
| Current Liabilities | | | |
| Financial Liabilities | | | |
| i) Borrowings | 42.1 | 166.4 | 233.4 |
| ii) Trade Payables | 421.6 | 426.6 | 462.2 |
| iii) Other | 70.3 | 36.4 | 43.5 |
| Other Current Liabilities | 185.5 | 79.1 | 18.9 |
| Short-term Provisions | 34.0 | 29.5 | 34.8 |
| Total Current Liabilities | 753.5 | 738.0 | 792.8 |
| Total Equity & Liabilities | 1,759.4 | 2,366.4 | 2,535.4 |

| Particulars (INR Mn) | FY24 | FY25 | H1FY26 |
|---------------------------------|----------------|----------------|----------------|
| Non-Current Assets | | | |
| Property Plant & Equipment | 634.7 | 579.3 | 608.0 |
| Other Intangible asset | 2.0 | 3.9 | 1.2 |
| Capital Work in progress | 47.2 | 357.6 | 529.9 |
| Financial Assets | | | |
| i) Investments | 88.6 | 38.5 | 40.5 |
| ii) Other | 32.7 | 32.5 | 32.4 |
| Other Non-current Assets | 7.3 | 6.0 | 5.1 |
| Total Non-Current Assets | 812.6 | 1,017.8 | 1,217.1 |
| Current Assets | | | |
| Inventories | 510.2 | 540.9 | 565.3 |
| Financial Assets | | | |
| i) Investments | - | - | - |
| ii) Trade Receivable | 315.4 | 376.0 | 393.5 |
| iii) Cash and Cash Equivalent | 96.8 | 378.0 | 280.5 |
| iv) Loans | 0.4 | 0.4 | 0.4 |
| v) Other | 0.3 | 0.1 | 0.1 |
| Current Tax Asset | 6.2 | 16.5 | 18.5 |
| Other current assets | 17.6 | 36.7 | 60.0 |
| Total Current Assets | 946.9 | 1,348.6 | 1,318.3 |
| Total Assets | 1,759.4 | 2,366.4 | 2,535.4 |

AWARDS & ACCOLADES



ICONIC BRAND AWARD

India's iconic brand 2025
PRIDE OF INDIA CONCLAVE
(ET NOW)



MANUFACTURING TODAY

NEXT GENERATION LEADER



RENAULT QUALITY AWARD

Best Supplier Quality



TV 9 AWARDS 2021

Company of the Year 2021 (Auto
& Auto Components)



EPC AAWARD

Export excellence award

THANK YOU

LETS FORGE
A KINETIC BOND!

KINETIC ENGINEERING LIMITED

Kinetic Innovation Park, D-1 Block Plot No. 18/2, MIDC Chinchwad
Pune – 411 019

Tel: 020-66142049

Email: kelinvestors@kineticindia.com

Website: www.kineticindia.com

KAPTIFY® Consulting

Strategy & Investor Relation | Consulting

Tel: +91 845 288 6099

Email: contact@kaptify.in

Website: www.kaptify.in

